



SEKTION N
NEUROCHIRURGIE



SECTION N
NEUROSURGERY

SECCIÓN N
NEUROCIROUGÍA

SEKTION N

Neurochirurgie

Handbohrapparate

Schädelhalter, -zange

Drahtsägen

Anlege- und Abnehmezange,
Clips

LEYLA Fixations-System

Fossa-Posterior-Spreizer

Nervwurzelhaken,
Duradissektoren,
Nervhäkchen

Mikro-Instrumente

Hypophysektomie-
Instrumente

Duramesser, Hirnspatel

Wirbelkörperspreizer

Laminektomiespreizer

Laminektomiestanzen,
-zangen

SECTION N

Neurosurgery

Hand Drills

Cervical Traction Tongs,
Cervical Forceps

Wire Saws

Applying and removing Forceps,
Clips

LEYLA Fixation System

Posterior Fossa Retractor

Nerve Root Retractors,
Dura Dissectors, Dura Hooks,
Nerve Hooks

Micro Instruments

Hypophysectomie
Instruments

Dura Knives, Brain Spatulas

Lamina Spreaders

Laminectomy Retractors

Laminectomy Punches and
Rongeurs

SECCIÓN N

Neurocirugía

Perforades de mano

Pinzas para tracción craneal,
pinza craneal

Sierras de hilo metálico

Pinzas-aplicadora y quitadora,
grapas

LEYLA Sistema de fijación

Separador para la fosa posterior

Disecadores y ganchos para
dura-madre y nervios

Instrumentos para microcirugía

Instrumentos para la
hipofisectomía

Bisturíes para dura-madre,
espátulas cerebrales

Separadores para laminectomía

Separadores para laminectomía

Pinzas cortantes para
laminectomía



NA 020-00
max. Ø 6,35 mm

RALK
Aluminiumgehäuse, mit Schlüssel
Aluminium body, with key
Cuerpo de aluminio, con llave

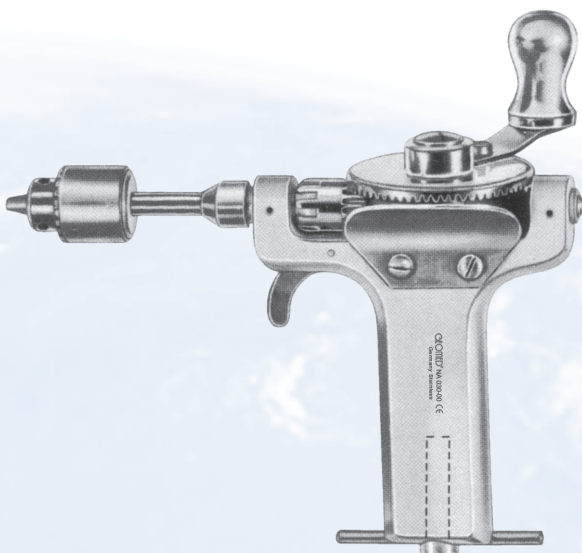

NA 030-00
max. Ø 4 mm

BUNNEL
Aluminiumgehäuse, mit Schlüssel
Aluminium body, with key
Cuerpo de aluminio, con llave

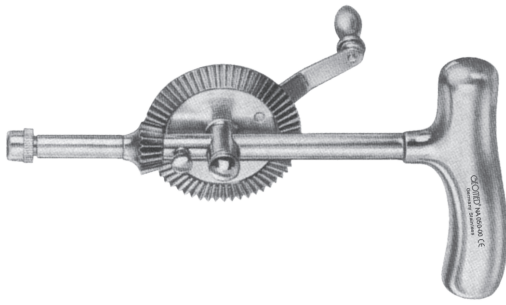

STILLE

NA 050-00

komplett
complete
completo

bestehend aus:
consisting of:
compuesto de:

Bohrapparat **NA 051-01**
Brace 20 cm / 8"
Perforador

Bohrer
drill bits
taladros



NA 053-03
Ø 2,0 mm



NA 053-04
Ø 2,5 mm



NA 053-05
Ø 3,0 mm



NA 053-06
Ø 3,5 mm



NA 053-07
Ø 4,0 mm



NA 053-08
Ø 10,0 mm



NA 053-09
Ø 5,0 mm



NA 053-10
Ø 8,0 mm



NA 053-11
Ø 12,0 mm

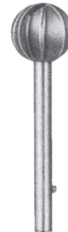

NA 053-12
Ø 16,0 mm



Zubehör
accessories
accesorios

NA 055-01
Ø 1,0 mm



NA 055-02
Ø 1,5 mm



NA 055-03
Ø 2,0 mm



HUDSON

NA 060-00

komplett
complete
completo

bestehend aus:
consisting of:
compuesto de:

Bohrapparat **NA 061-01**
Brace 27 cm / 10³/₄"
Perforador



NA 062-01

Verlängerungsstück
Extension piece
Pieza de prolongación



NA 063-01
Ø 9,0 mm



NA 063-02
Ø 14,0 mm



NA 063-03
Ø 16,0 mm



NA 063-04
Ø 22,0 mm

Fräser
burrs
fresas



Ø 14,0 mm
Ø 10,0 mm
Ø 12,0 mm
Ø 13,0 mm
Ø 15,0 mm
Ø 16,0 mm

NA 063-05
NA 063-10
NA 063-12
NA 063-13
NA 063-15
NA 063-16



NA 063-06
Ø 2,0 mm
Spiralbohrer
twist drills
taladro espiral



MC KENZIE
NA 063-07
Ø 13,0 mm
Spiralbohrer
twist drills
taladro espiral



D'ERRICO
NA 063-08
Ø 16,0 mm
Spiralbohrer
twist drills
taladro espiral

Zubehör
accessories
accesorios
CUSHING
Flachbohrer
drills
taladro plano

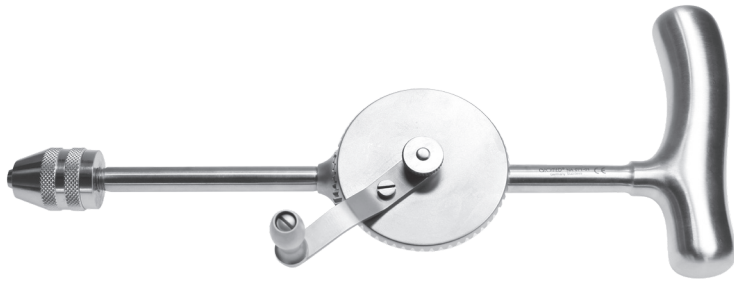

MOORE

NA 070-00
komplett
complete
completo

bestehend aus:
consisting of:
compuesto de:

Bohrapparat **NA 071-01**
Brace 28 cm / 11"
Perforador

NA 073-00

∅ 3,2 mm
Satz Spiralbohrer
Set of twist drills 7 cm / 2¾"
Juego de taladros espirales 9 cm / 3½"



2 x **NA 073-07**
1 x **NA 073-09**

N

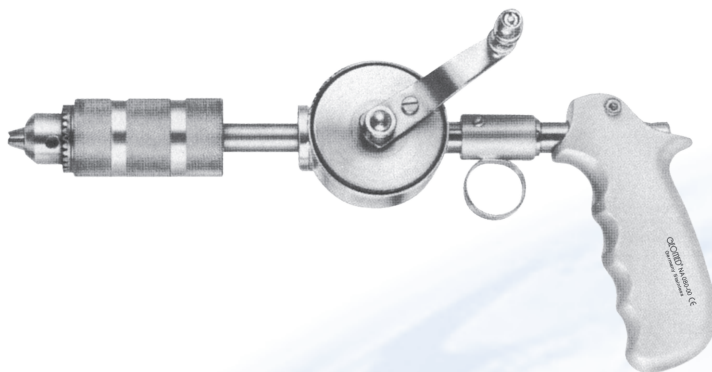

NA 080-00
28 cm / 11"
max. ∅ 8 mm

komplett
complete
completo

Aluminiumgriff umklappbar, mit Schlüssel
Tilttable aluminium handle, with key
Mango de aluminio plegable, con llave

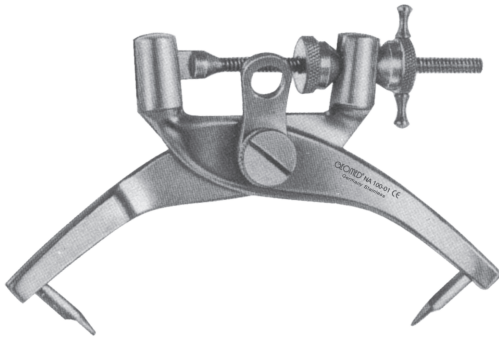

NA 100-01

CRUTCHFIELD

klein
small
pequeño



NA 100-02

CRUTCHFIELD

mittel
medium
medio



Ø 3,5 mm | **NA 103-03**
Ø 5,0 mm | **NA 103-05**

CRUTCHFIELD

Vorbohrer
drill points
perforadores iniciales



CASPAR

Spiralbohrer
Twist drill
Taladros espirales

NA 110-00

Ø 1,7 mm

Schraubendreher
Screwdriver
Destornillador

NA 110-01

20 cm / 8"

Distractionsschrauben
Distraction screw
Distracción tornillo

12 mm

NA 112-12

14 mm

NA 112-14

16 mm

NA 112-16

18 mm

NA 112-18



Großes Modell, für Extension der Halswirbel, mit 2 verstellbaren Dornen
Large pattern, for extension of neck vertebrae, with 2 adjustable pins
Modelo grande, para la extensión de las vértebras de cuello, con 2 puntas ajustables

NA 120-00
komplett
complete
completo

NA 122-01
Ersatzdorn
spare pin
punta de repuesto



NA 131-15

ADSON
15 cm / 6"
Bohrloch-Schutzzange
Bore holding protection forceps
pinza de protección



NA 140-20

20,5 cm / 8"
Bohrloch-Schutzzange
Bore holding protection forceps
pinza de protección



NA 150-21

DE VILBISS

21 cm / 8¼"

mit 1 Ersatzklinge

with 1 spare blade

con 1 hoja de repuesto

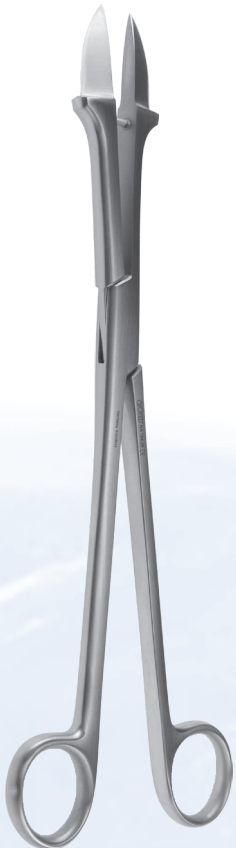

NA 164-28

SMELLIE

28 cm / 11"



NA 200-01

OLIVECRONA

Hakengriff für Drahtsägen
Hook handle for wire saws
Mango con gancho para sierras de hilo



30 cm / 12"	NA 201-30
40 cm / 15¾"	NA 201-40
50 cm / 20"	NA 201-50
60 cm / 24"	NA 201-60
70 cm / 27½"	NA 201-70

OLIVECRONA (GIGLI)

Drahtsägen
Wire saws
Sierras de hilo metálico



NA 220-33
33 cm / 13"

MARTEL



15 cm / 6"
19 cm / 7½"

NA 300-15
NA 300-19

NA 301-15
NA 301-19

MCKENZIE



NA 307-23

SWEET
23 cm / 9"



NA 320-16

RANEY
16 cm / 6¼"

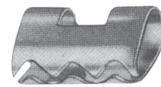

NA 330-00

RANEY
Kopfhautklammer
Scalp clip
Grapa para cuero cabelludo



NA 360-00

100 Silberklammern in Plastikbehälter
100 Silver brain clips in plastic vial
100 Grapas de plata en tubo de plástico

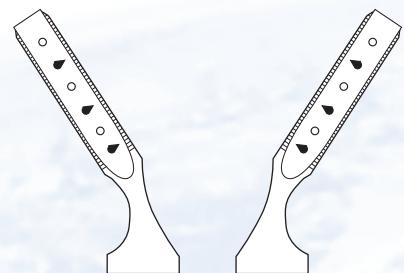

31 cm / 12¼" | **NA 380-31**
41 cm / 16¼" | **NA 380-41**

YASARGIL

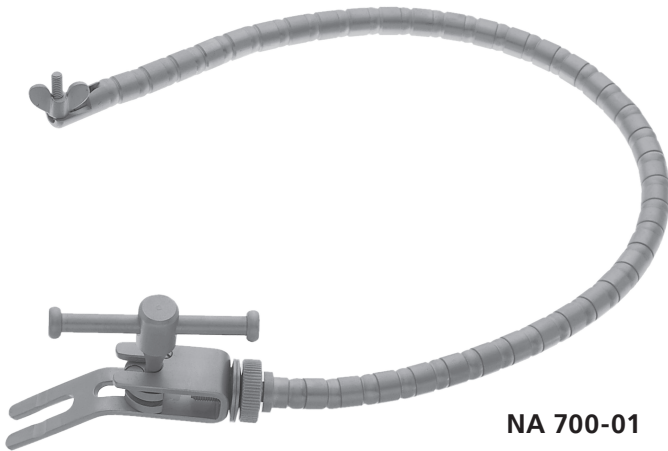

NA 700-01

LEYLA
Flaxibler Spannarm
Flaxible Arm
Brazo flexible



NA 700-02

LEYLA
Fixiervorrichtung für 1 Arm am Schädel
Fixation for 1 arm at skull
Fijador para 1 brazo al cráneo



NA 700-03

LEYLA
Fixiervorrichtung für 2 Arme am Schädel
Fixation for 2 arms at skull
Fijador para 2 brazos al cráneo



NA 700-04

LEYLA
Fixiervorrichtung für 1 Arm an Rohrteilen bis Ø 16 mm
Fixation for 1 arm on bars up to Ø 16 mm
Fijador para 1 brazo para atornillar a tubos hasta Ø 16 mm



NA 701-01

LEYLA

Halter für Hirnspatel mit rundem Schaft
Support for round brain spatula
Porta-espátula con vástago redondo



NA 703-01

LEYLA

Halter für Hirnspatel
Support for flat brain spatula
Porta-espátula para espátulas planas



NA 711-01

LEYLA

Haltearm zur Fixation im Kugelgelenk-Klemmsattel
Holding rod for fixation in ball and clamp socket
Brazo de apoyo para fijar la articulación esférica



NA 710-25

LEYLA

Kugelgelenk-Klemmsattel zur Befestigung an OP Tisch Schienen
Ball and clamp socket for fixation on operation table rail
Articulación esférica, para sujetar los brazos sobre la mesa de operaciones



NA 712-01

LEYLA

Kopplungskopf für max. 5 flexible Spannarme NA 700-01
Coupling head for up to 5 flexible arms NA 700-01
Acoplamiento para sujetar max. 5 brazos NA 700-01

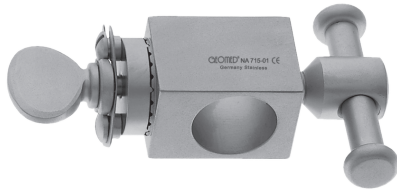

NA 715-01

LEYLA

Kupplungskopf drehbar für 1 flexibler Spannarm NA 700-01
Coupling head turnable for 1 flexible arm NA 700-01
Acoplamiento, girable para fijar 1 brazo NA 700-01

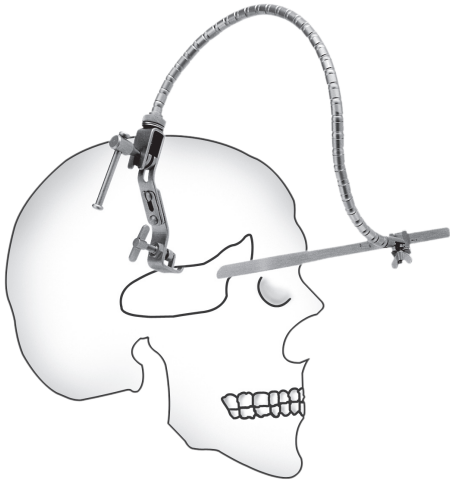

NA 740-00

LEYLA

selbsthaltender Hirnsattel mit 1 Spannarm komplett
Self-retainig brain retractor with 1 flexible arm complete
Separador autorretentivo con 1 brazo completo

bestehend aus: 1 x **NA 700-01**
including: 1 x **NA 700-02**
compuesto de: 1 x **NA 703-01**

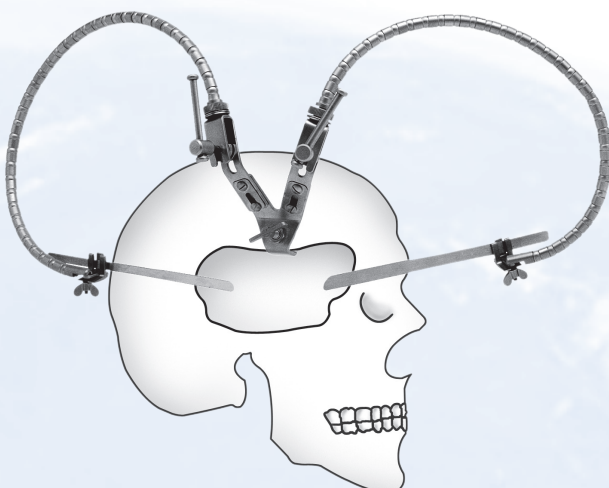

NA 750-00

LEYLA

selbsthaltender Hirnsattel mit 2 flexiblen Spannarmen komplett
Self-retainig brain retractor with 2 flexible arms complete
Separador autorretentivo con 2 brazos completo

bestehend aus: 2 x **NA 700-01**
including: 1 x **NA 700-02**
compuesto de: 2 x **NA 703-01**



komplett
complete
completo

NA 800-00

bestehend aus:
including:
compuesto de:

Sperrer allein
frame only
cuadro sólo

NA 801-01

4 x 4 teeth

JANNETTA

18 cm / 7"



2 x **NA 802-01**

10,5 cm / 4¼"

Einfache Fixiervorrichtung mit 2 Gelenken
Single fixation bar with 2 swivels
Torno de fijación singular con 2 articulaciones



2 x **NA 802-02**

19 cm / 7½"

Doppelte Fixiervorrichtung mit 3 Gelenken
Double fixation bar with 3 swivels
Torno de fijación doble con 2 articulaciones

Hirnspatel
brain spatula
espátulas cerebrales



16,5 cm / 6½" 70 x 15 mm
75 x 20 mm
75 x 25 mm

NA 803-01
NA 803-02
NA 803-03

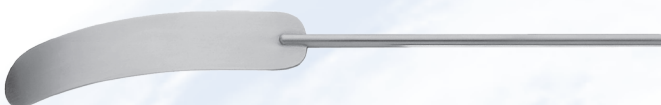

18 cm / 7" 95 x 5 mm
95 x 10 mm
95 x 20 mm

NA 805-01
NA 803-02
NA 803-03



HARDY
23 cm / 9"
2 mm

NC 080-24
aufgebogen
curved up
curva arriba

NC 082-24
abgebogen
curved down
curva abajo



CASPAR
24 cm / 9½"

4 mm
6 mm
8 mm
10 mm

NC 090-04
NC 090-06
NC 090-08
NC 090-10



D'ERRICO
22,5 cm / 8¾"

NC 095-22



NC 101-21
aufgewinkelt
angled on flat
angulado de plano

21 cm / 8¼"



NC 117-18
5 mm

LOVE
11 cm / 4¼"



NC 110-19
gerade
straight
recta

LOVE
19 cm / 7½"



NC 111-19
abgewinkelt
angled to side
angulado de lado

LOVE
19 cm / 7½"

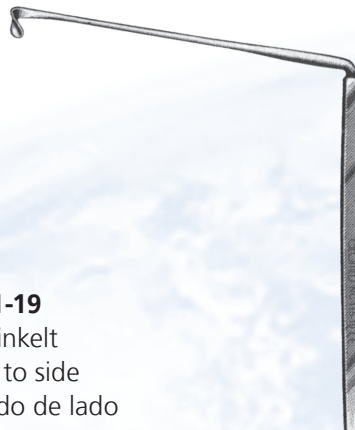

NC 115-19
abgewinkelt
angled to side
angulado de lado

LOVE
19 cm / 7½"



NC 120-23
7 mm

SCOVILLE
23 cm / 9"



NC 121-20
8 mm

SCOVILLE
20 cm / 8"



NC 131-24
7 mm

HOLSHER
24 cm / 9½"



NC 141-20
6 mm

HORSLEY
20 cm / 8"





NC 146-01 NC 146-02

CASPAR
20,5 cm / 8"



NC 151-21

SACHS
21 cm / 8¼"



NC 161-01
1

PENFIELD
17,5 cm / 7"
leicht gebogen
light curved
curva ligera



NC 161-02
2

PENFIELD
19,5 cm / 7¾"
leicht gebogen
light curved
curva ligera



NC 161-03
3

PENFIELD
19,5 cm / 7¾"
stark gebogen
strong curved
curva fuerte

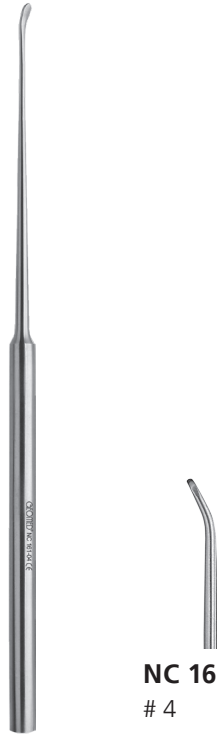

NC 161-04
4

PENFIELD
21,5 cm / 8½"
leicht gebogen
light curved
curva ligera



NC 161-05
5

PENFIELD
27,5 cm / 10¾"
leicht gebogen
light curved
curva ligera



14 cm / 5½" ; 5 mm
23,5 cm / 9¼" ; 7 mm

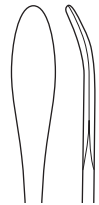

NC 171-14
NC 171-23

SCHMID



NC 201-24

DAVIS

24,5 cm / 9¾"



NC 211-22

22 cm / 8¾"



Fig 1 **NC 221-01**
Fig 2 **NC 221-02**
Fig 3 **NC 221-03**
Fig 4 **NC 221-04**

ROBB

24,5 cm / 9¾"



NC 231-21

MILLIGAN
21 cm / 8¼"



NC 240-21
21 cm / 8¼"



NC 241-19
19 cm / 7½"

DAVIS
6 mm



NC 243-21

SACHS
21 cm / 8¼"



18 cm / 7"
21 cm / 8¼"

NC 251-18
NC 251-21

3 mm
intima-spatel
intima spatula
espátula para la íntima



NC 281-25
25 cm / 10"

TOENNIS



NC 285-25
25 cm / 10"

WOODSON

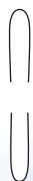

18 cm / 7"
24 cm / 9½"

NC 291-18
NC 291-24

OLIVECRONA
feines Modell
fine pattern
modelo delgado



19,5 cm / 7¾"
24 cm / 9½"

NC 293-19
NC 293-24



OLIVECRONA

gebogen
curved
curvo



FRAZIER

15 cm / 6"

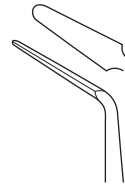

NC 295-15



NC 297-01
45°

NC 297-02
45°

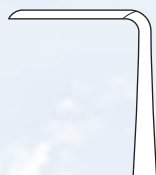

HOEN

15 cm / 6"



CUSHING



14 cm / 5½"



NC 300-14



13 cm / 5"
18 cm / 7"

stumpf blunt romo	spitz sharp agudo
	
NC 310-13 NC 310-18	NC 314-13 NC 314-18

FRAZIER



NC 330-16

GRAHAM

16,5 cm / 6½"
stumpf
blunt
romo



NC 340-18

SACHS

18 cm / 7"
spitz
sharp
agudo



NC 350-15

TOENNIS

15 cm / 6"
spitz
sharp
agudo





NC 354-22

HOEN
22 cm / 8¾"



19 cm / 7½"
28 cm / 11"

CUSHING

kurz
short
corto

lang
long
largo



NC 360-19
NC 360-28



NC 362-19
NC 362-28



NC 370-20
stumpf
blunt
romo



NC 374-20
spitz
sharp
agudo

ADSON
20 cm / 8"



NC 381-20
1



NC 385-20
2

CRILE
20 cm / 8"
Nervhäkchen
Nerve Hooks
Ganchios para nervios



NC 390-18

18 cm / 7"
scharf
sharp
romo



NC 392-18

FISCH
18 cm / 7"
scharf
sharp
romo



**NC 400-01
NC 400-02
NC 400-03**

CHUSHING-LANDOLT
Hypophysectomie
Hypophysectomy
Hipofisectomia



NC 400-21

LANDOLT
21 cm / 8¼"



17 cm / 6³/₄"
21 cm / 8¹/₄"



NC 411-17
NC 411-21

SMITHWICK



KRAYENBÜHL
18,5 cm / 7¹/₄"



NC 420-01
1



NC 420-02
2



NC 420-03
3

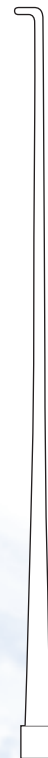

NC 420-04
4



NC 425-01	NC 425-02	NC 425-03	NC 425-04
# 1	# 2	# 3	# 4

CASPAR

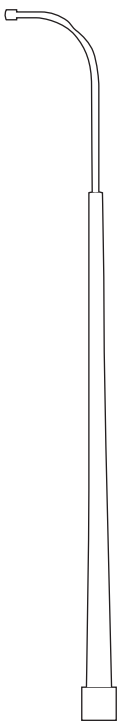

NC 430-01

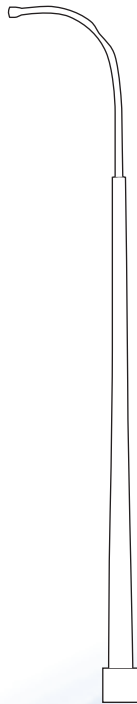

NC 430-02



NC 430-03

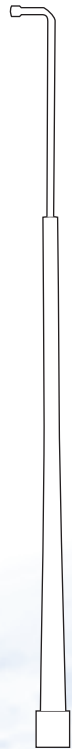

NC 430-04

YASARGIL

19 cm / 7½"

Fadenführer, geknöpft

Ligature guider, pointed

Guía-ligadura. abotonada



NC 450-23

23 cm / 9"
Fadenführer
Ligature Adjuster
Horquilla de hilos



NC 470-01

YASARGIL
19 cm / 7½"



NC 470-02

YASARGIL
19 cm / 7½"



NC 470-03

YASARGIL
19 cm / 7½"



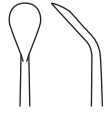

NC 470-04

YASARGIL
19 cm / 7½"



NC 470-05

YASARGIL
19 cm / 7½"



NC 470-06

YASARGIL
19 cm / 7½"



2 mm | **NC 480-02**
3 mm | **NC 480-03**

23 cm / 9"
Raspatorium
Raspatory
Legra



NC 481-19

18,5 cm / 7½"
Durahaken
Dura Hooks
Ganchios para dura-madre



NC 490-01

YASARGIL
19 cm / 7½"
Fadengabel
Twin Probe
Sonda doble



NC 491-00
aufwärts
up
arriba

NC 491-01
abwärts
down
abajo

YASARGIL
19 cm / 7½"
Arachnoides Messer
arachnoid knife
chucillo aracnoid



NC 491-02



NC 491-03



NC 491-04

YASARGIL
19 cm / 7½"
Raspatorium
Raspatory
Legra



NC 491-05

YASARGIL
19 cm / 7½"
Schaefer Löffel
Sharp Scoop
Cucharilla cortante



NC 492-16

BIEMER

16 cm / 6¼"

Gefäßperrerr

Vessel spreader

Separadores para vasos



NC 494-01

gerade
straight
recta

NC 494-02

90°

NC 494-03

90°

NC 494-04

45°

RHOTON

19 cm / 7½"



NC 500-19

JACOBSON

18,5 cm / 7½"

Gefäßmesser

Vessel Knife

Cuchillo para vasos



- # 1
- # 2
- # 3
- # 4
- # 5
- # 6

- NC 503-01
- NC 503-02
- NC 503-03
- NC 503-04
- NC 503-05
- NC 503-06

KOOS
19 cm / 7½"



- 1,8 mm | NC 507-01
- 2,5 mm | NC 507-02

SAMII
23 cm / 9"



- 1,5 mm | NC 507-15
- 3,0 mm | NC 507-30
- 4,5 mm | NC 507-45
- 6,0 mm | NC 507-60

SAMII
23 cm / 9"



- NC 510-19
- NC 512-19

JACOBSON
18,5 cm / 7¼"





Ø 3 mm
Ø 4 mm
Ø 5 mm

45°	90°	45°
NC 521-03	NC 523-03	NC 525-03
NC 521-04	NC 523-04	NC 525-04
NC 521-05	NC 523-05	NC 525-05

RAY
18,5 cm / 7¼"



NC 527-04
4,0 mm

KRAMER
25 cm / 10"



4 mm
6 mm
NC 551-04
NC 551-06

HARDY
26 cm / 10¼"



	stumpf blunt romo	scharf sharp agudo
links left izquierda	 NC 560-01	NC 564-01
rechts right derecha	NC 560-02	NC 564-02

HARDY
24,5 cm / 9³/₄"



NC 568-24

HARDY
24,5 cm / 9³/₄"
Implantationsgabel
Implant fork
Horquilla para implantar



NC 574-01 **NC 574-02**
links rechts
left right
izquierda derecha

HARDY (-FAHLBUSCH)
24,5 cm / 9³/₄"
Dissektor
Dissector
Disecador



Ø 4,5 mm **NC 576-23**
Ø 2,0 mm **NC 578-23**

23 cm / 11"
Mikrodissektor
Micro Dissector
Micro Disecador



NC 590-04
4 mm

PAPAVERO
22 cm / 8½"
Flachmeißel
Chisel
Cinceles

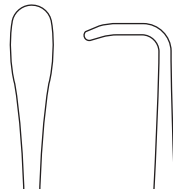

NC 610-29

SMITHWICK
29 cm / 11½"
Nervehäkchen
Nerve Hook
Ganchios para nervios



NC 620-20

HALLE
20 cm / 8"



NC 630-20

DANDY
20 cm / 8"



NC 671-01
oben
up
arriba

NC 671-02
unten
down
abajo

NC 671-03
rechts
right
derecho

NC 671-04
links
left
izquierdo

NUCY
16 cm / 6¼"



17 cm / 6³/₄" ; 8 / 10 mm
19,5 cm / 7³/₄" ; 13 / 15 mm
27,5 cm / 10³/₄" ; 16 / 18 mm

NC 700-01
NC 700-02
NC 700-03

CUSHING



NC 714-22
10 mm

SCOVILLE
22 cm / 8¹/₂"



7 x 9 mm
11 x 13 mm
15 x 18 mm
18 x 22 mm

konkav
concave
concavas

konvex
convex
convexas

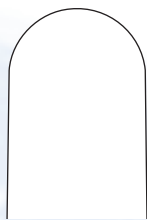

NC 731-01
NC 731-02
NC 731-03
NC 731-04

NC 735-01
NC 735-02
NC 735-03
NC 735-04

OLIVECRONA
18 cm / 7"



7 + 8 mm	NC 750-08
10 + 11 mm	NC 750-11
13 + 14 mm	NC 750-14
16 + 17 mm	NC 750-17
19 + 20 mm	NC 750-20
22 + 25 mm	NC 750-25

HEIFETZ

20 cm / 8"

biegsam, flach
malleable, flat
maleables, planas



14 mm	NC 760-14
17 mm	NC 760-17
20 mm	NC 760-20

HEIFETZ

20 cm / 8"

biegsam, Rundschaft
malleable, round shaft
maleables, vástago redondo



NL 101-16

CLOWARD
16 cm / 6¼"



NL 121-15

CLOWARD
15 cm / 6"



16 cm / 6¼" | **NL 131-16**
27 cm / 10¾" | **NL 131-27**

INGE
16 cm / 6¼"



SCOVILLE

Rahmen allein
Frame only
Cuadro Solo

Spreizweite
Spread
Abertura

NL 161-01
150 mm / 6"



SCOVILLE-HAVERFIELD

Rahmen allein
Frame only
Cuadro Solo

Spreizweite
Spread
Abertura

NL 165-01
150 mm / 6"



SCOVILLE

50 mm / 2"
70 mm / 2¾"
75 mm / 3"

stumpf
blunt
romo



NL 170-01
NL 170-02
NL 170-03

scharf
sharp
agudo



NL 174-01
NL 174-02
NL 174-03



SCOVILLE
gezahnt
serrated
dentada

64 x 25 mm
64 x 50 mm
88 x 25 mm

NL 176-01
NL 176-02
NL 176-03



TAYLOR
scharf
sharp
aguda

25 x 41 mm
44 x 38 mm
50 x 41 mm

3 teeth

NL 177-01
NL 177-02
NL 177-03

4 teeth

48 x 50 mm
64 x 50 mm
64 x 64 mm
80 x 57 mm
41 x 38 mm
67 x 44 mm

NL 178-01
NL 178-02
NL 178-03
NL 178-04
NL 178-05
NL 178-06



CLOWARD

komplett
complete
completo

NL 240-00

15 cm / 6"

bestehend aus:
consisting of:
compuesto de:

Sperrer allein; spreizweite
Frame only; spread
Cuadro Solo; abertura

NL 241-01

55 mm

Seitenvalve
lateral blade
valva lateral

40 mm

45 mm

50 mm

55 mm

60 mm

- 1 x **NL 243-40**
- 1 x **NL 243-45**
- 1 x **NL 243-50**
- 1 x **NL 243-55**
- 1 x **NL 243-60**



CLOWARD

komplett
complete
completo

NL 250-00

25 cm / 10"

bestehend aus:
consisting of:
compuesto de:

Sperrer allein
Frame only
Cuadro Solo

NL 251-01

Seitenvalve; gezahnt
lateral blade; serrated
valva lateral; dentada

40 mm

45 mm

50 mm

55 mm

60 mm

- 1 x **NL 253-40**
- 1 x **NL 253-45**
- 1 x **NL 253-50**
- 1 x **NL 253-55**
- 1 x **NL 253-60**





HOEN

komplett
complete
completo

NL 270-00
27 cm / 10¼"

bestehend aus:
consisting of:
compuesto de:

Sperrer allein
Frame only
Cuadro Solo

NL 271-01

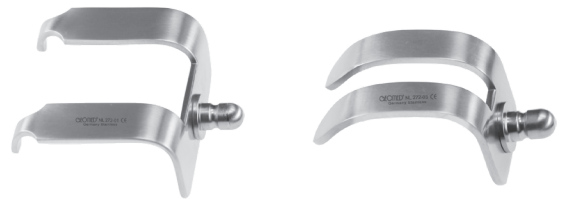

Seitenvalve
lateral blade
valva lateral

35 x 45 mm
45 x 45 mm

NL 272-01
NL 272-02

35 x 25 mm
45 x 25 mm

NL 272-03
NL 272-04



Spekula für lumbale Bandscheibenoperationen, schwarz verchromt
Specula for lumbar vertebral operations, black chrome-plated
Especúlos para operaciones de vertebrae lumbares, cromados de negro

40 mm
45 mm
50 mm
55 mm
60 mm

NL 300-40
NL 300-45
NL 300-50
NL 300-55
NL 300-60



Gegensperrer, schwarz verchromt
Counter-retractor, black chrome-plated
Contraseparador, cromado de negro

komplett
complete
completo

NL 330-00

bestehend aus:
consisting of:
compuesto de:

Sperrer allein; Spreizweite
Frame only; spread
Cuadro Solo; abertura

NL 331-01
60 mm / 2 1/2"

Seitenvalve
lateral blade
valva lateral

schwarz verchromt
black chrome-plated
cromado de negro



35 mm
40 mm
45 mm
50 mm
55 mm
60 mm
65 mm
75 mm
85 mm

NL 333-35
NL 333-40
NL 333-45
NL 333-50
NL 333-55
NL 333-60
NL 333-65
NL 333-75
NL 333-85

40 mm
45 mm
50 mm
55 mm
60 mm
65 mm
70 mm

NL 335-40
NL 335-45
NL 335-50
NL 335-55
NL 335-60
NL 335-65
NL 335-70



80 x 11 mm | **NL 340-01**
90 x 13 mm | **NL 340-02**
100 x 15 mm | **NL 340-03**

PAPAVERO-CASPAR

Spekulas
Specula
Espéculos

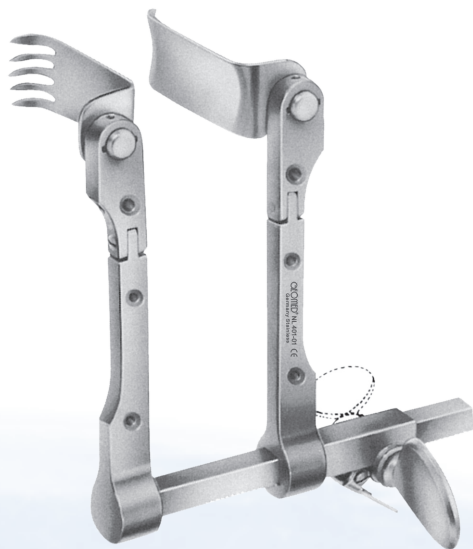

CASPAR

Sperrer mit Gelenken
Retractor adjustable
Separador con articulación

komplett | **NL 400-00**
complete | 12 cm / 4¾"
completo

bestehend aus:
consisting of:
compuesto de:

Sperrer allein | **NL 401-01**
Frame only | 90 mm
Cuadro Solo



latterale Blätter | 40 x 23 mm
lateral blades | 45 x 23 mm
valvas laterales | 50 x 23 mm
55 x 23 mm
60 x 23 mm

NL 406-40
NL 406-45
NL 406-50
NL 406-55
NL 406-60



Mediale Blätter | 40 x 23 mm
medial blades | 45 x 23 mm
valvas mediales | 50 x 23 mm
55 x 23 mm
60 x 23 mm

NL 407-40
NL 407-45
NL 407-50
NL 407-55
NL 407-60



CASPAR

Gegensperrer mit Gelenkan
Counter-retractor with adjustable
Contraseparador con articulación

komplett
complete
completo

NL 420-00
16,5 cm / 6½"

bestehend aus:
consisting of:
compuesto de:

Sperrer allein; Spreizweite
Frame only; spread
Cuadro Solo; abertura

NL 421-01
90 mm

stumpfe Blätter
blunt blades
valvas romas

40 x 23 mm **NL 422-40**
45 x 23 mm **NL 422-45**
50 x 23 mm **NL 422-50**
55 x 23 mm **NL 422-55**
60 x 23 mm **NL 422-60**

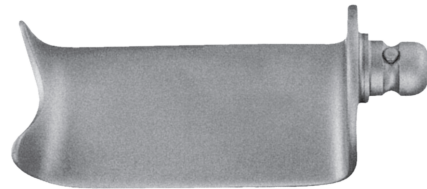

CASPAR

komplett
complete
completo

NL 430-00
rechts
right
derecha

NL 432-00
links
left
izquierda

bestehend aus:
consisting of:
compuesto de:



NL 430-01
rechts
right
derecha

NL 432-01
links
left
izquierda

Hohlmeißel
Gouges
Gubias



NL 430-02
rechts
right
derecha

NL 432-02
links
left
izquierda

Wirbelkörperdistraktor allein
Vertebral body distractor only
Distractor del cuerpo vertebral solo



NL 430-03

Wendelbohrer
twist drill
fresa espiral



NL 430-04

Schraubendreher
screwdriver
destornillador

CASPAR

komplett **NL 440-00**
complete
completo

bestehend aus:
consisting of:
compuesto de:



NL 440-01
Schlüssel
key
clave



38 mm **NL 440-02**
58 mm **NL 440-04**
Häkchen
hook
ganchios

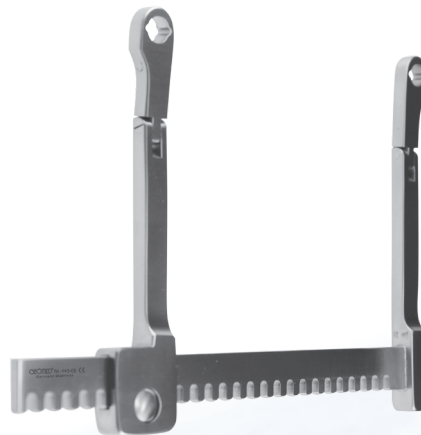

NL 440-03
Pinzette zum Wechseln der Valven
Blade changing forceps
Pinza para cambiar las valvas

NL 440-05
Sperrer allein
Retractor only
Separador solo



32 x 52 mm	NL 440-32	32 x 37 mm	NL 441-32	32 x 22 mm	NL 442-32
37 x 52 mm	NL 440-37	37 x 37 mm	NL 441-37	37 x 22 mm	NL 442-37
42 x 52 mm	NL 440-42	42 x 37 mm	NL 441-42	42 x 22 mm	NL 442-42
47 x 52 mm	NL 440-47	47 x 37 mm	NL 441-47	47 x 22 mm	NL 442-47
52 x 52 mm	NL 440-52	52 x 37 mm	NL 441-52	52 x 22 mm	NL 442-52
57 x 52 mm	NL 440-57	57 x 37 mm	NL 441-57	57 x 22 mm	NL 442-57
62 x 52 mm	NL 440-62	62 x 37 mm	NL 441-62	62 x 22 mm	NL 442-62
67 x 52 mm	NL 440-67	67 x 37 mm	NL 441-67	67 x 22 mm	NL 442-67



FERRIS-SMITH-KERRISON

Bissbreite Width of bite Anchura de la boca	Schaftlänge Length of shaft Longitud del vástago	90° aufwärts; mit Auswerfer up; with ejector arriba; con eyector	40° aufwärts up arriba	90° abwärts; mit Auswerfer down; with ejector abajo; con eyector
1 mm	18 cm / 7"	NS 510-01	NS 511-01	NS 512-01
2 mm	15 cm / 6" 18 cm / 7" 20 cm / 8" 23 cm / 9"	NS 510-15 NS 510-18 NS 510-20 NS 510-23	NS 511-15 NS 511-18 NS 511-20 NS 511-23	NS 512-15 NS 512-18 NS 512-20 NS 512-23
3 mm	15 cm / 6" 18 cm / 7" 20 cm / 8" 23 cm / 9"	NS 520-15 NS 520-18 NS 520-20 NS 520-23	NS 521-15 NS 521-18 NS 521-20 NS 521-23	NS 522-15 NS 522-18 NS 522-20 NS 522-23
4 mm	15 cm / 6" 18 cm / 7" 20 cm / 8" 23 cm / 9"	NS 526-15 NS 526-18 NS 526-20 NS 526-23	NS 527-15 NS 527-18 NS 527-20 NS 527-23	NS 528-15 NS 528-18 NS 528-20 NS 528-23
5 mm	15 cm / 6" 18 cm / 7" 20 cm / 8" 23 cm / 9"	NS 530-15 NS 530-18 NS 530-20 NS 530-23	NS 531-15 NS 531-18 NS 531-20 NS 531-23	NS 532-15 NS 532-18 NS 532-20 NS 532-23
6 mm	15 cm / 6" 18 cm / 7" 20 cm / 8" 23 cm / 9"	NS 509-15 NS 509-18 NS 509-20 NS 509-23	NS 519-15 NS 519-18 NS 519-20 NS 519-23	NS 518-15 NS 518-18 NS 518-20 NS 518-23

Alle Ferris-Smith-Kerrison auch **mit Dünnfuss** lieferbar. Bitte den Artikelnummern die Endnummer -11 hinzufügen.
All Ferris-Smith-Kerrison available **with thin foot**. Please add "-11" to the item number mentioned above.
Todas pinzas Ferris-Smith-Kerrison las son adquiribles también **con lámina de pie plano**. Por favor agregan el número "-11" al número de artículo



FERRIS-SMITH-KERRISON

Bissbreite Width of bite Anchura de la boca	Schaftlänge Length of shaft Longitud del vástago	90° aufwärts; mit Auswerfer up; with ejector arriba; con eyector	40° aufwärts up arriba	90° abwärts; mit Auswerfer down; with ejector abajo; con eyector
1 mm	15 cm / 6" 18 cm / 7" 20 cm / 8" 23 cm / 9"	NS 533-15 NS 533-18 NS 533-20 NS 533-23	NS 545-15 NS 545-18 NS 545-12 NS 545-23	NS 549-15 NS 549-18 NS 549-20 NS 549-23
2 mm	15 cm / 6" 18 cm / 7" 20 cm / 8" 23 cm / 9"	NS 534-15 NS 534-18 NS 534-20 NS 534-23	NS 535-15 NS 535-18 NS 535-20 NS 535-23	NS 536-15 NS 536-18 NS 536-20 NS 536-23
3 mm	15 cm / 6" 18 cm / 7" 20 cm / 8" 23 cm / 9"	NS 538-15 NS 538-18 NS 538-20 NS 538-23	NS 539-15 NS 539-18 NS 539-20 NS 539-23	NS 540-15 NS 540-18 NS 540-20 NS 540-23
4 mm	15 cm / 6" 18 cm / 7" 20 cm / 8" 23 cm / 9"	NS 542-15 NS 542-18 NS 542-20 NS 542-23	NS 543-15 NS 543-18 NS 543-20 NS 543-23	NS 544-15 NS 544-18 NS 544-20 NS 544-23
5 mm	15 cm / 6" 18 cm / 7" 20 cm / 8" 23 cm / 9"	NS 546-15 NS 546-18 NS 546-20 NS 546-23	NS 547-15 NS 547-18 NS 547-20 NS 547-23	NS 548-15 NS 548-18 NS 548-20 NS 548-23

Alle Ferris-Smith-Kerrison auch **mit Dünnfuss** lieferbar. Bitte den Artikelnummern die Endnummer -11 hinzufügen.
All Ferris-Smith-Kerrison available **with thin foot**. Please add "-11" to the item number mentioned above.
Todas pinzas Ferris-Smith-Kerrison las son adquiribles tambien **con lámina de pie plano**. Por favor agregan el numero "-11" al numero de articulo

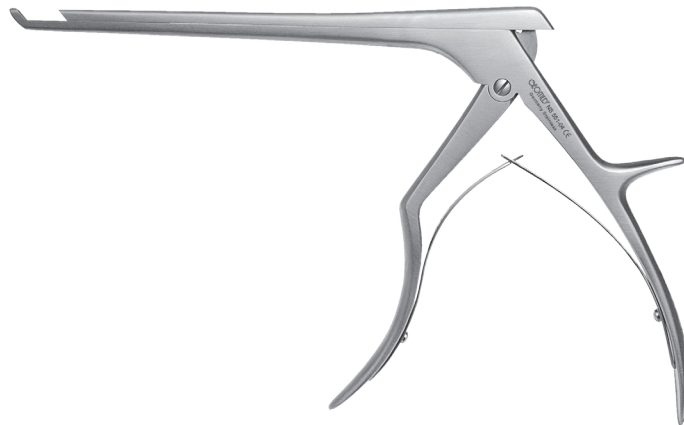

LOVE-KERRISON

Bissbreite Width of bite Anchura de la boca	Schaftlänge Length of shaft Longitud del vástago	90° aufwärts up arriba	40° aufwärts up arriba	90° abwärts down abajo
1 mm	18 cm / 7" 20 cm / 8"	NS 550-01 NS 560-01	NS 551-01 NS 561-01	NS 552-01 NS 562-01
2 mm	18 cm / 7" 20 cm / 8"	NS 550-02 NS 560-02	NS 551-02 NS 561-02	NS 552-02 NS 562-02
3 mm	15 cm / 6" 18 cm / 7" 20 cm / 8"	NS 553-03 NS 550-03 NS 560-03	NS 551-03 NS 561-03	NS 554-03 NS 552-03 NS 562-03
4 mm	18 cm / 7" 20 cm / 8"	NS 550-04 NS 560-04	NS 551-04 NS 561-04	NS 552-04 NS 562-04
5 mm	18 cm / 7" 20 cm / 8"	NS 550-05 NS 560-05	NS 551-05 NS 561-05	NS 552-05 NS 562-05
6 mm	18 cm / 7" 20 cm / 8"	NS 550-06 NS 560-06	NS 551-06 NS 561-06	NS 552-06 NS 562-06

Alle Ferris-Smith-Kerrison auch **mit Dünnfuss** lieferbar. Bitte den Artikelnummern die Endnummer -11 hinzufügen.
All Ferris-Smith-Kerrison available **with thin foot**. Please add "-11" to the item number mentioned above.
Todas pinzas Ferris-Smith-Kerrison las son adquiribles también **con lámina de pie plano**. Por favor agregan el número "-11" al número de artículo

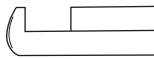
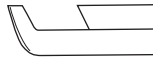
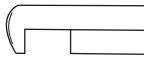

FERRIS-SMITH-KERRISON
18 cm / 7"

Bissbreite Width of bite Anchura de la boca	90° aufwärts up arriba	40° aufwärts up arriba	90° abwärts down abajo
			
3 mm	NS 600-03	NS 601-03	NS 602-03
5 mm	NS 600-05	NS 601-05	NS 602-05



FERRIS-SMITH
18 cm / 7"

Maul jaw boca	gerade straight recta	aufwärts up arriba	abwärts down abajo
2 x 10 mm	NS 620-02	NS 621-02	NS 622-02
2 x 10 mm	NS 620-03	NS 621-03	NS 622-03
4 x 10 mm	NS 620-04	NS 621-04	NS 622-04
5 x 10 mm	NS 620-05	NS 621-05	NS 622-05
6 x 12 mm	NS 620-06	NS 621-06	NS 622-06

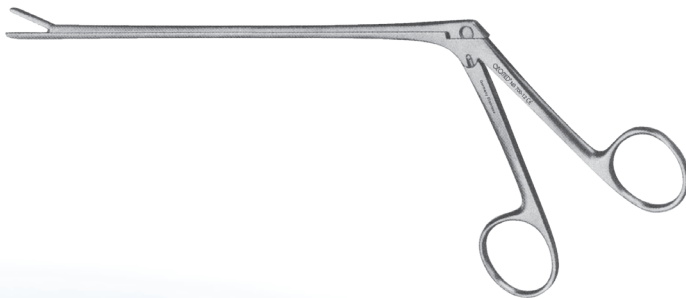

CUSHING
2 x 10 mm

Schaft shaft tubo	gerade straight recta	aufwärts up arriba	abwärts down abajo
12 cm / 4¾"	NS 700-12	NS 702-12	NS 704-12
15 cm / 6"	NS 700-15	NS 702-15	NS 704-15
18 cm / 7"	NS 700-18	NS 702-18	NS 704-18

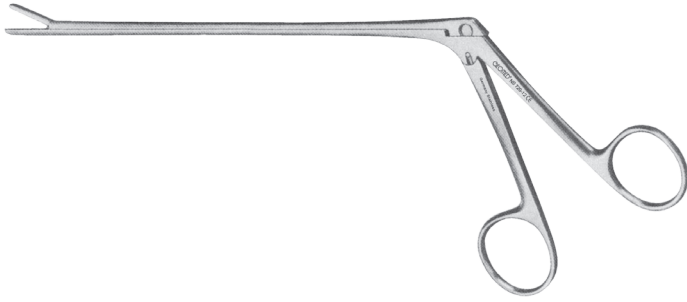

LOVE-GRUENWALD

3 x 10 mm

Schaft shaft tubo	gerade straight recta	aufwärts up arriba	abwärts down abajo
12 cm / 4¾"	NS 720-12	NS 722-12	NS 724-12
15 cm / 6"	NS 720-15	NS 722-15	NS 724-15
18 cm / 7"	NS 720-18	NS 722-18	NS 724-18

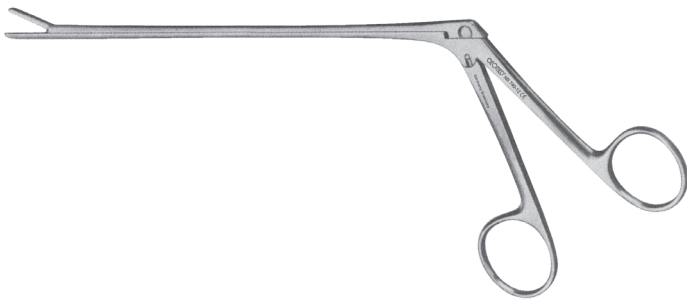

SPURLING

4 x 10 mm

Schaft shaft tubo	gerade straight recta	aufwärts up arriba	abwärts down abajo
12 cm / 4¾"	NS 740-12	NS 742-12	NS 744-12
15 cm / 6"	NS 740-15	NS 742-15	NS 744-15
18 cm / 7"	NS 740-18	NS 742-18	NS 744-18



SCHLESINGER
15 cm / 6"

2 x 10 mm
3 x 10 mm
4 x 10 mm



NS 750-02
NS 750-03
NS 750-04



OLDBERG
18 cm / 7"



NS 760-18
7 mm



YASARGIL
18 cm / 7"



NS 770-25
3 mm
scharf
sharp
cortante

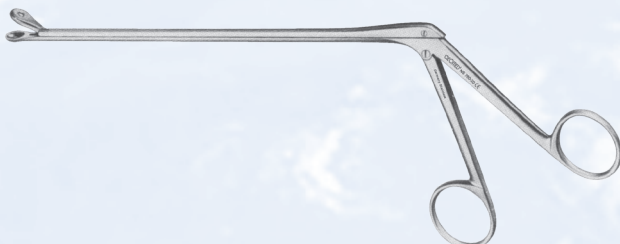

LANDOLT
20 cm / 8"



NS 780-20
9 mm
stumpf
blunt
roma



CASPAR
15,5 cm / 6"

Maul jaw boca	gerade straight recta	aufwärts up arriba	abwärts down abajo
2 mm	NS 850-15	NS 852-15	NS 854-15
3 mm	NS 860-15	NS 862-15	NS 864-15
4 mm	NS 870-15	NS 872-15	NS 874-15
5 mm	NS 880-15		



CASPAR

Bissbreite Width of bite Anchura de la boca	Schaftlänge Length of shaft Longitud del vástago	gerade straight recta	aufwärts up arriba	abwärts down abajo
2 x 12 mm	14 cm / 5½" 16 cm / 6¼" 18,5 cm / 7¼"	NS 900-14 NS 900-16 NS 900-18	NS 902-14 NS 902-16 NS 902-18	NS 904-14 NS 904-16 NS 904-18
3 x 12 mm	14 cm / 5½" 16 cm / 6¼" 18,5 cm / 7¼"	NS 910-14 NS 910-16 NS 910-18	NS 912-14 NS 912-16 NS 912-18	NS 914-14 NS 914-16 NS 914-18
4 x 12 mm	14 cm / 5½" 16 cm / 6¼" 18,5 cm / 7¼"	NS 920-14 NS 920-16 NS 920-18	NS 922-14 NS 922-16 NS 922-18	NS 924-14 NS 924-16 NS 924-18
5 x 14 mm	14 cm / 5½" 16 cm / 6¼" 18,5 cm / 7¼"	NS 930-14 NS 930-16 NS 930-18	NS 932-14 NS 932-16 NS 932-18	NS 934-14 NS 934-16 NS 934-18
6 x 16 mm	14 cm / 5½" 16 cm / 6¼" 18,5 cm / 7¼"	NS 940-14 NS 940-16 NS 940-18		